

GROUP 15 POLES AND ACCESSORIES FOR "TV" ANTENNA

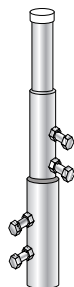

Telescopic pole



Hot-galvanised telescopic pole with 70 ÷ 80 micron protection. Pole thickness 0.8 ÷ 1.0 mm

Item	Length/each element m	Total length m	ø mm	Weight/each	Pcs per box
A22	2,0	4,0	25÷30	Kg 2,250	5
A23	2,0	6,0	25÷35	Kg 3,800	5
A24	2,0	8,0	25÷40	Kg 5,650	5
A25	2,0	10,0	25÷45	Kg 8,050	2
A251	2,0	12,0	25÷50	Kg 11,00	2

Telescopic pole

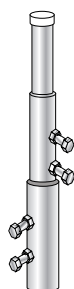

Hot-galvanised telescopic pole with 70 ÷ 80 micron protection. Pole thickness 1.4 ÷ 1.5 mm

Item	Length/each element m	Total length m	ø mm	Weight/each	Pcs per box
A26	2,0	4,0	25÷30	Kg 3,520	5
A27	2,0	6,0	25÷35	Kg 6,400	3
A28	2,0	8,0	25÷40	Kg 8,750	2
A29	2,0	10,0	25÷45	Kg12,000	2

Telescopic pole with 3 bolts

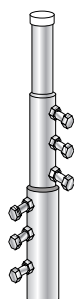

Hot-galvanised telescopic pole with 70 ÷ 80 micron protection. Pole thickness 2.0. With 3 aligned locking bolts.



Item	Length/each element m	Total length m	ø mm	Weight/each	Pcs per box
A83	2,0	4,0	28÷35	Kg 5,820	3
A831	2,0	6,0	28÷42	Kg 9,750	2

Single element

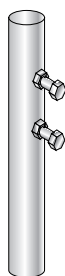

Hot-galvanised single pole with 70 ÷ 80 micron protection, appropriate for telescopic poles composition.

Item	Length/each element m	ø mm	Pole thickness	Weight/each	Pcs per box
A30	2,0	25	1,0	Kg 0,965	10
A31	2,0	30	1,0	Kg 1,260	5
A32	2,0	35	1,0	Kg 1,450	5
A34	2,0	25	1,5	Kg 1,595	10
A35	2,0	30	1,5	Kg 2,175	5
A36	2,0	35	1,5	Kg 2,415	5
A37	2,0	40	1,5	Kg 2,930	5
A38	3,0	25	1,5	Kg 2,390	5
A39	3,0	30	1,5	Kg 3,265	5
A40	3,0	35	1,5	Kg 3,620	5
A41	3,0	40	1,5	Kg 4,400	3
A42	3,0	28	2,0	Kg 3,840	5
A43	3,0	35	2,0	Kg 4,890	3
A44	3,0	42	2,0	Kg 5,910	2
A45	3,0	50	2,0	Kg 7,110	2

GROUP 15 POLES AND ACCESSORIES FOR "TV" ANTENNA



Modular single element	Item	Length/each element m	ø mm	Weight/each	Pcs per box
------------------------	------	-----------------------	------	-------------	-------------



Hot-galvanised modular single pole with 70 ÷ 80 micron protection, pole thickness 1.4 mm.

Material going out of stock

A46 ***	1,0	25	Kg 0,470	10
A47	1,5	25	Kg 0,710	10

Pole for fastening under the roof	Item	Length/each element m	Appropriate for poles ø mm	Weight/each	Pcs per box
-----------------------------------	------	-----------------------	----------------------------	-------------	-------------

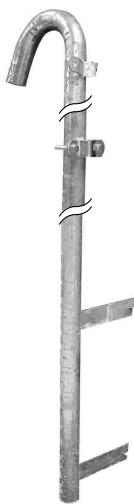

Hot-galvanised pole with bend for fastening under the roof with 70 ÷ 80 micron protection, pole diameter 42 mm. Thickness 2 mm.

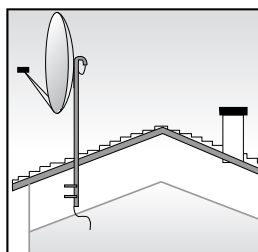

A48	2,0	25 ÷ 45	Kg 5,00	1

Telescopic cramp	Item	Appropriate for poles ø mm	Weight/each	Pcs per box
------------------	------	----------------------------	-------------	-------------

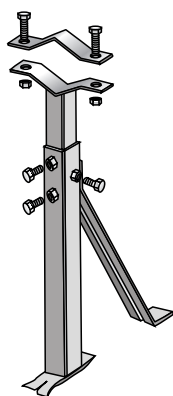

Telescopic cramp to wall, adjustment from 40 to 70 cm Hot-galvanised.

A50		40 ÷ 90	Kg 4,950	4

Telescopic cramp	Item	Appropriate for poles ø mm	Weight/each	Pcs per box
------------------	------	----------------------------	-------------	-------------

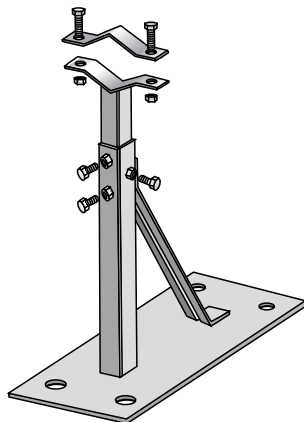

Telescopic cramp with drilled fixing plate, adjustment from 40 to 70 cm Hot-galvanised.

A51		40 ÷ 90	Kg 5,900	4

GROUP 15 POLES AND ACCESSORIES FOR "TV" ANTENNA



Chimney cramp	Articolo	Appropriate for poles of \varnothing mm	Weight/each	Pcs per box
---------------	----------	---	-------------	-------------

Steel chimney cramp
30x4mm. Electrogalvanised.

A52	25 ÷ 45	Kg 0,900	30

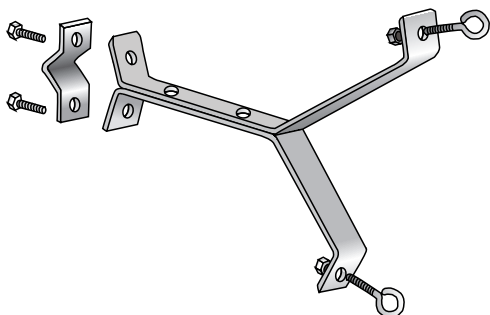

Wall cramp	Item	Weight/each	Pcs per box
------------	------	-------------	-------------

Hot-galvanised wall cramp.
Appropriate for poles of \varnothing 35
to 80 mm. Height 10 cm.

A53	Kg 0,900	10

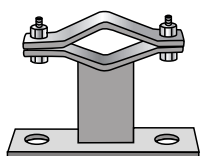

Balcony cramp	Item	Appropriate for poles of \varnothing mm	Weight/each	Pcs per box
---------------	------	---	-------------	-------------

Steel balcony cramp
30x3mm. Electrogalvanised.

A54	25 ÷ 45	Kg 0,480	30

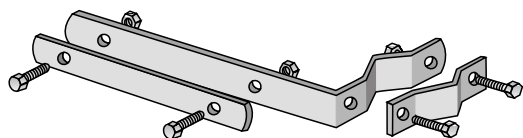

Wall cramp	Item	length in mm	sezione nastro mm	Weight/each	Pcs per box
------------	------	--------------	-------------------	-------------	-------------

Electrogalvanised steel cramp
to wall. Appropriate for poles
of \varnothing 25 to 50 mm.

A55	230	30 x 3	Kg 0,250	50
A56	330	30 x 4	Kg 0,430	50

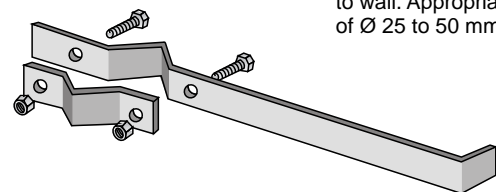

Wall cramp	Item	length in mm	Weight/each	Pcs per box
------------	------	--------------	-------------	-------------

Reinforced galvanised steel
cramp to wall. Appropriate for
poles of \varnothing 30 ÷ 60 mm.

A57	230	Kg 0,560	25
A58	300	Kg 0,730	25
A59	400	Kg 0,895	25

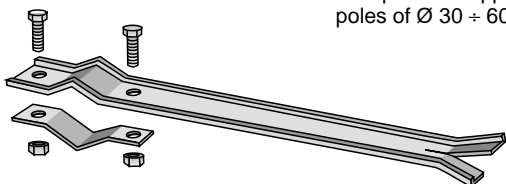

GROUP 15 POLES AND ACCESSORIES FOR "TV" ANTENNA



Universal clamp	Item	Appropriate for poles of \varnothing mm	Weight/each	Pcs per box
-----------------	------	---	-------------	-------------

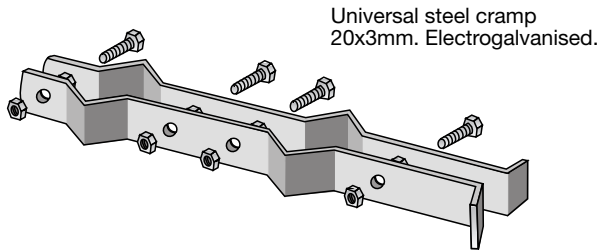

Universal steel clamp
20x3mm. Electrogalvanised.

A60	25 ÷ 50	Kg 0,330	50

Guard clamp	Item	Weight/each	Pcs per box
-------------	------	-------------	-------------

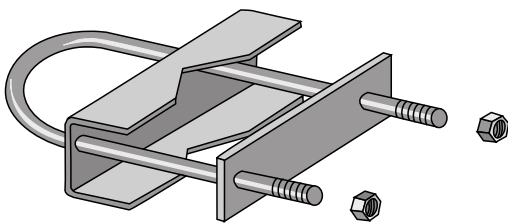

Electrogalvanised guard
steel clamp. Appropriate for
poles of \varnothing 25 ÷ 40 mm.

A61		Kg 0,145	100

Rod fastening clamp	Item	Appropriate for poles of \varnothing mm	Weight/each	Pcs per box
---------------------	------	---	-------------	-------------

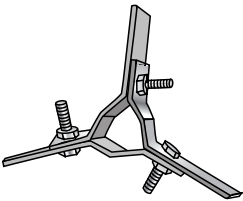

Electrogalvanised steel rod
fastening clamp.

A63	25 ÷ 35	Kg 0,150	100

Double U-bolt	Item	Appropriate for poles of \varnothing mm	Weight/each	Pcs per box
---------------	------	---	-------------	-------------

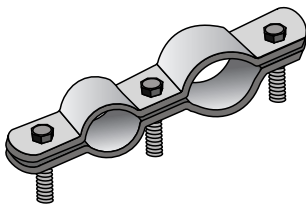

Electrogalvanised steel
double U-bolt.

A70	25 ÷ 25	Kg 0,240	100
A71	25 ÷ 35	Kg 0,260	100

Universal U-bolt	Item	Weight/each	Pcs per box
------------------	------	-------------	-------------

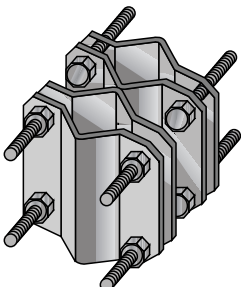

Galvanised steel universal
double U-bolt. Appropriate
for poles of \varnothing 25 ÷ 50 mm.

A72		Kg 0,900	25

GROUP 15 POLES AND ACCESSORIES FOR "TV" ANTENNA



Spaced U-bolt	Item	Weight/each	Pcs per box
---------------	------	-------------	-------------

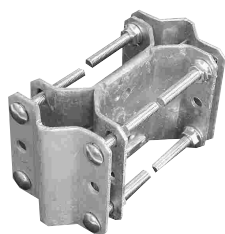

Universal double U-bolt with spacing plate of 90x60x6 mm Hot-galvanised steel. Appropriate for poles \varnothing 25 \pm 50 mm.



A84		Kg 1,250	20

French cramp	Item	Model	Weight/each	Pcs per box
--------------	------	-------	-------------	-------------

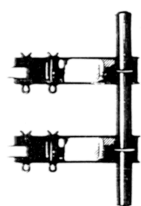

Galvanised steel cramp for single chimney, French type.



A73	Single	Kg 0,900	10
A731	Double	Kg 1,950	6

Galvanised strip	Item	Skein length	Weight/each	Pcs per box
------------------	------	--------------	-------------	-------------

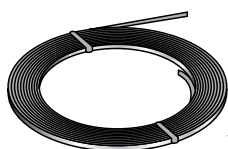

Galvanised steel strip 40x0.5 mm, appropriate to fix the French types cramps.



A73L	mt. 25	Kg 4,000	1
A73P	mt. 5	Kg 0,800	1

Expansion cramp	Item	length in mm	Appropriate for poles of \varnothing mm	Weight/each	Pcs per box
-----------------	------	--------------	---	-------------	-------------

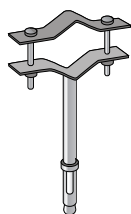

Electrogalvanised steel expansion cramp, heavy type with solid round bar.



A 741	50	30÷60	kg 0,280	30
A 74	100	30÷60	kg 0,390	30
A 75	200	30÷60	kg 0,600	20
A 76	300	30÷60	kg 0,980	20

"U" cramp	Item	Appropriate for poles of \varnothing mm	Weight/each	Pcs per box
-----------	------	---	-------------	-------------

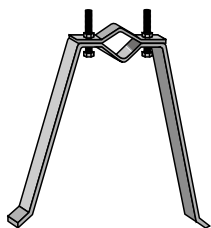

Electrogalvanised steel "U" cramp, strip section 40x4 mm.

A 77	30÷60	kg 1,050	5

Reinforced "U" cramp	Item	Height in mm	Appropriate for poles \varnothing mm	Weight/each	Pcs per box
----------------------	------	--------------	--	-------------	-------------

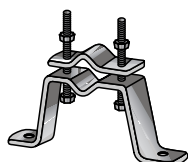

Reinforced hot-galvanised steel "U" cramp, strip section 40x5 mm.

A 78	100	30 ÷ 80	kg 0,815	10
A 79	200	30 ÷ 80	kg 1,650	10
A 80	300	30 ÷ 80	kg 2,525	5